



TS-03 Pneumatic Crimp Machine

Pic. 1-1

GENERAL INFORMATION

TS-03 is a brand new design, desktop four-indent pneumatic crimping machine, used to crimping the wire and contact in electronic connectors.

WIRE SIZE: from 53-10.5mm² 1/0AWG- 7AWG

Gears Range: continuous adjustment from 3.0-8.0mm.

Through-hole Dia. : 21.5mm



Crimp Sample

Pic. 2-1



Section View

Pic. 2-2

WORKING PRINCIPLES

1. The crimp machine adopts curve propulsion mechanism, its applied force transfers through four curves in the head cavity of the right plier handle to the four indenters. The four indenters do the centripetal linear motion, which makes its front-end teeth crimp the contact to complete the crimping process. The cycle controlled precision ratchet assures the consistency of impression and the crimping quality of wires and contacts.
2. The stroke control is adopted inside the crimp machine to ensure the consistency of the crimping. If the air pressure is insufficient or the air supply time is too short and the crimping cannot be completed correctly, the pressure block will not be retracted because the mechanical switch of the stroke control is not turned on. At this time, the air pressure should be adjusted or the air supply time should be increased to make the pressure block movement reach the selector position. The machine is restored to normal use. (It can also be reset by using the reset switch, but the crimped contacts should be properly detected and processed)
3. The crimp machine is controlled by the screw rod, and the selector position can be continuously adjusted. Each time the adjusting knob is rotated by 1/4 turn, the crimping diameter changes by 0.1mm, and the value of each millimeter changes with the increase of the gear position. With an increase of 0.01 mm. Accurate and precise continuous adjustment can be achieved.
4. This crimp machine is controlled by its own foot valve. The working air pressure is adjusted and controlled by the pressure regulating valve. Usually, the continuous crimping is not returned due to the shortage of the air source. It is recommended to adjust the air pressure to 0.6MPa or more.

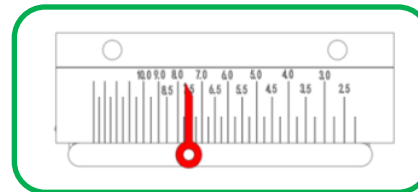

Dial Gauge

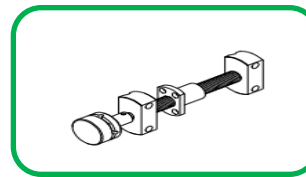

Regulating mechanism

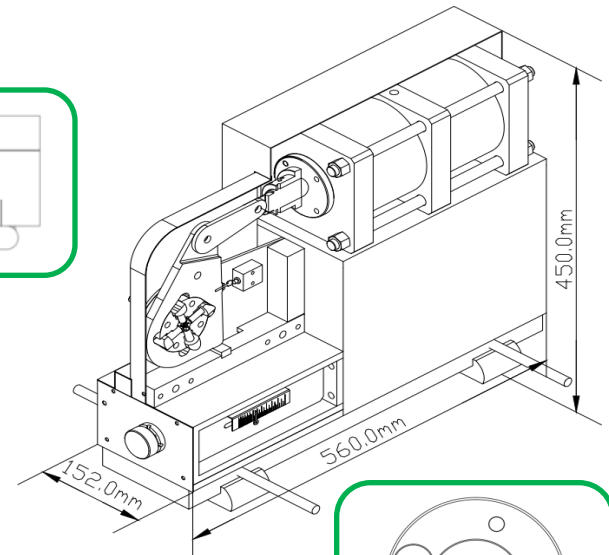

Structure

Pic. 3-1

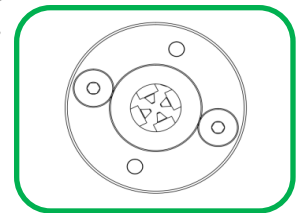

Crimping mechanism

2. Operating Instructions

1). Connect the air source, connect the foot treadle, pressure regulating valve, air tube, open the air source valve

2). Gear adjustment: under the indent opening, firstly lift the gear button, rotate the button to clockwise, gear increase, rotate to anti-clockwise, gear decrease. Make sure the pointer in right dial is directed at the needed calibration. Put down the gear button. Test the crimping diameter by suitable gage before operation.

3). Gear calibration: standing on the treadle switch, make the indent close. Put gage into the crimping hole, test whether can go through or not.

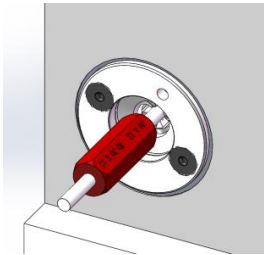

Gage Test-GO

Pic 4-1

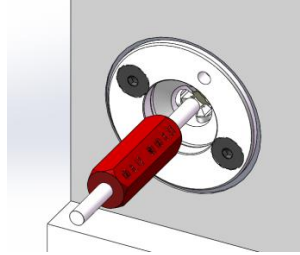

Gage Test-NO GO

Pic 4-2

4). Installing positioner: varies customized positioner available (purchase separately). Must under the indent open, rive the locking screw to make paddle can move. Align the positioner at axle hole and guideway, stir the paddle, fix the positioner, screw the locking screw. Adjust the length of screw rod, lock the jam nut.



Varies Positioners

Pic 4-3

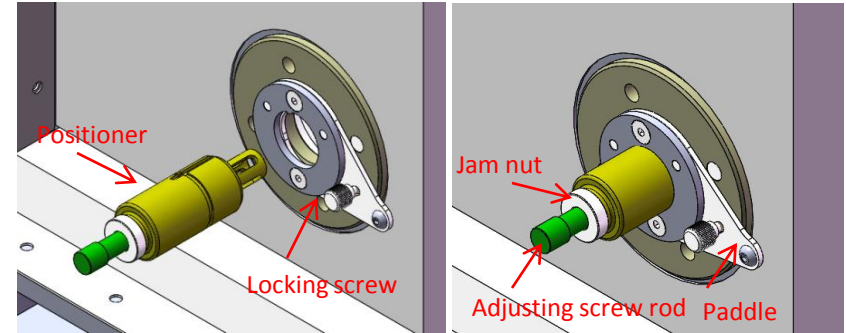

Installing the Positioner

Pic 4-4

5). Usage of reset switch: The reset switch is located on the top left side of the front panel. When big diameter contact is crimped in small gear or stuck hard things in crimp indents, please use less than $\Phi 5.0$ round stick to press the reset button. Indent will open automatically.

6). Crimp instruction: put the contact and wire, use foot treadle to apply air source, after crimping, loosen the foot treadle.

7). Delayer adjustment instructions: Added a delay device to extend the dwell time and avoid the inconsistency of the terminal crimping caused by manual operation. The factory setting time is 1-2s.

8). Foot switch connection instructions:

Foot switch interface P/A,
Device interface P OUT / A IN,
Connect accordingly.

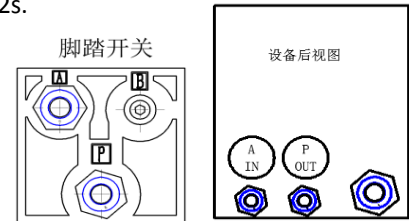

3.Attention:

- 1). Do not crimp the hard steel contact or solid or extremely thick contact. When big diameter contact is crimped in small gear or stuck hard things in crimp indents, please use less than $\Phi 5.0$ round stick to press the reset button. Indent will open automatically.
- 2). Working air pressure: 80-120 P.S.I. Max. air pressure: 120P.S.I.(5.5-8.3BAR).
- 3). Clean the indent and positioner hole after operation.